



Profile 10F User Manual

For Products: Vivid Wave Mini

PLEASE READ THESE INSTRUCTIONS CAREFULLY BEFORE INSTALLATION.
INCORRECT INSTALLATION AND HANDLING CAN **VOID YOUR WARRANTY**.

Table of Contents

Unpacking	2	Troubleshooting	15
White Box	2	3-Year limited Warranty	16
Basic Specifications	3	Appendix	17
Safety/Warnings	4		
Cutting Instructions	5		
Swivel Connector Assembly	6-8		
Basic Wiring Diagrams	9		
Static	9		
Mounting Channels	10-14		
Standard, Plastic, Spring Clip	10		
Do's & Don'ts	11-14		

Unpacking

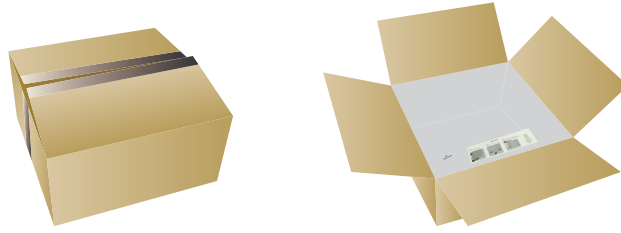

White Box - Custom Fixtures 65ft (20m) Or Less

Use the extraction channel built into the plastic tray to unpack the fixtures. This channel ensures that there will be no improper bending or twisting and helps avoid excessive force being applied to the internal components.



Gloves have been provided to avoid smudging the surface of the fixtures.

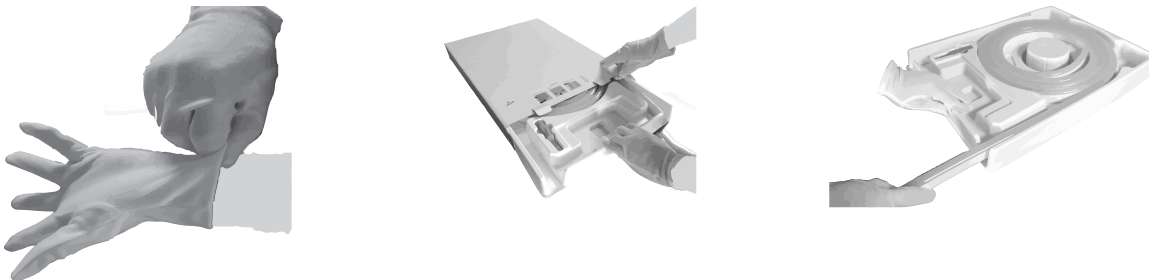

DO NOT attempt to remove the fixtures from the white plastic tray without using the channel.



General Specs

- Operating temperature: -4°F ~ 113°F (-20°C ~ 45°C) (High Voltage: -4°F ~ 95°F (-20°C ~ 35°C))
- Installation (bending) temperature: 32°F ~ 113°F (0°C ~ 45°C)
- Top View or Side View profile
- For full details and specs please refer to the product's Spec Sheet

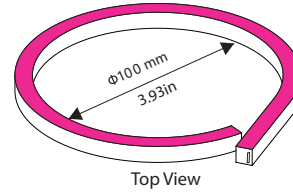
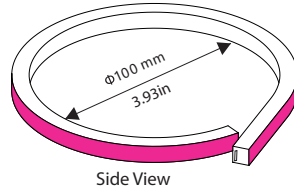
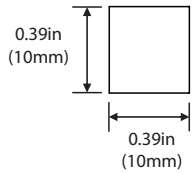

Light Type 160° Profile

Fixture	Color	Working Voltage	Rtd Power	Min. Cutting Unit	Max Run Length	
					Single Feed	Double Feed
Vivid Wave Mini	R/G/B/A/W	DC 24V CV	1.37W/ft (4.5W/m)	3.28in (83.3mm) (12 LEDs)	32.81ft (10m)	65.62ft (20m)

Safety/Warnings

- Before making any cuts, installation, maintenance or connection, be sure the fixture is disconnected!
- Note: all connectors must be assembled correctly to achieve IP67 rating.
- Fixture's rated voltage must match that of the power supply.
- Power supply must be constant voltage.
- Incorrectly cutting this product will damage the fixture.
- Do not power the light for over 30 minutes in coil packaging.
- Do not bend past the minimum diameter (Fig. 1) or twist this fixture (Fig. 3, 5). Doing so will result in damaging the internal circuit board.
- Do not bend the fixture in the opposite direction of its specified bending direction (Fig. 2, 4). Doing so will damage the internal circuit board.
- Do not operate all channels of color changing fixtures simultaneously at full capacity for extended periods of time.
- Do not put undue stress or pull excessively on the cables or injection connectors. This can cause the connectors to detach or fail. (see page 24-27)
- To extend the life of your fixtures, do not operate lights in daylight temperatures exceeding 140°F (60°C). Doing so will decrease the lifespan of the LEDs.

Correct

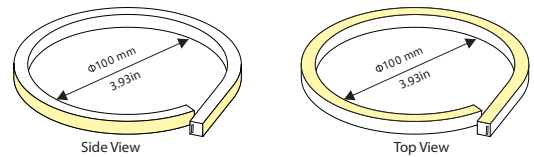

Fig. 1

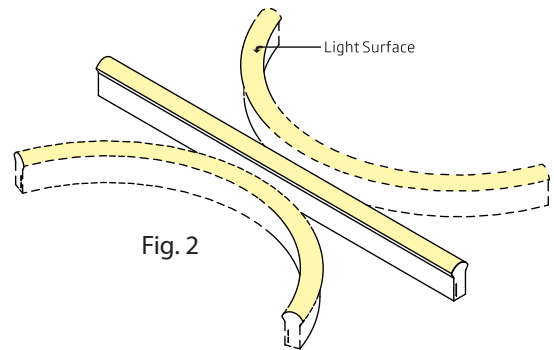

Fig. 2

Incorrect

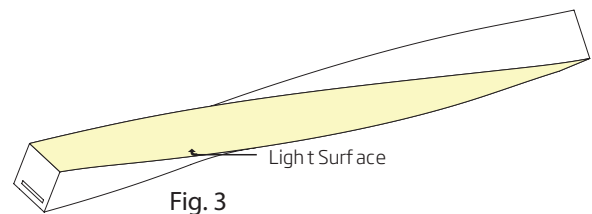

Fig. 3

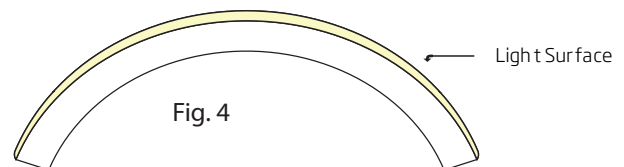

Fig. 4

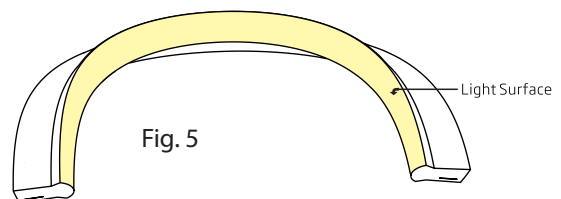
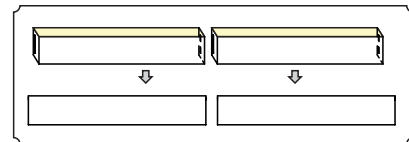
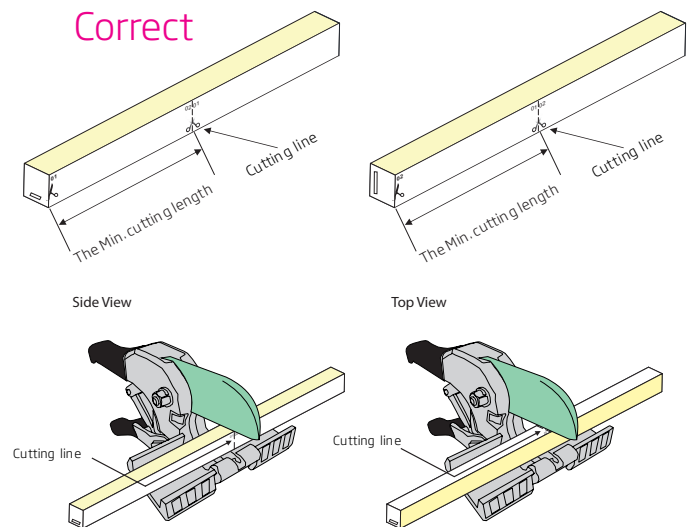

Fig. 5

Cutting Instructions

Note:

1. Place the light so the circuit board lies horizontally when cutting it. On a top view fixture, this is with the light surface facing upwards. On a side view fixture this is with the light surface facing to the side.
2. Use only factory-recommended cutter.
3. Cut the light according to the following instructions. Incorrect cutting & operation will damage the circuitry.



Incorrect

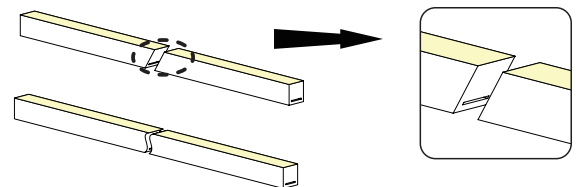
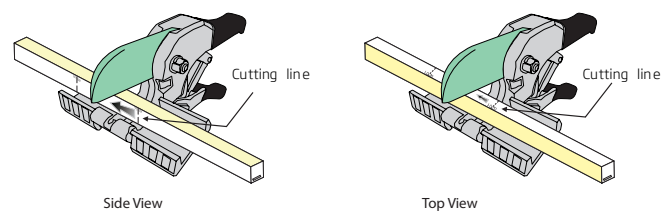

DO NOT CUT ON AN ANGLE.

Swivel Connector & End Cap Assembly

IP20 when assembled correctly. **Top View Images Shown**

Swivel Connector

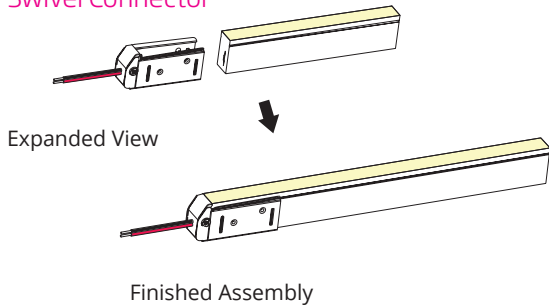

Swivel End Cap

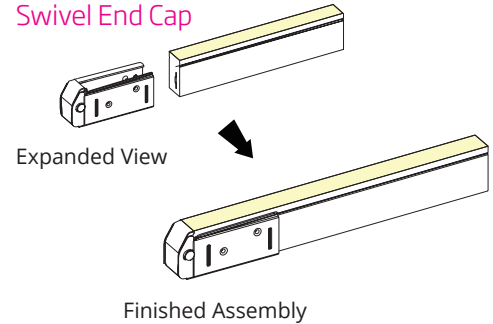

Before Beginning:

Always select the correct connector for the end of the light. Connectors are marked with an 01 and 02 and correspond with the printed numbers on the fixture.

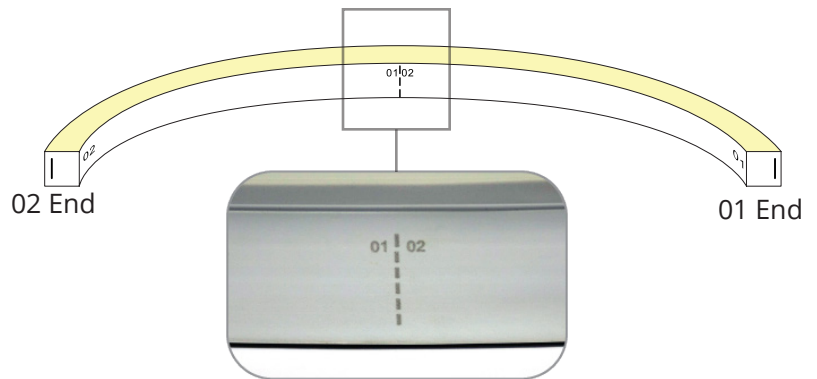

01 | Components of Swivel Connector/ End Cap



02 | Tools



Swivel Connector & End Cap Assembly

03 | Installation Steps

03.1 | Creating a gap for the Lead Connector

Insert the expanding tool behind the PCB. Move the tool up and down 3 to 5 times gently to create a small gap.

NEVER insert the expanding tool into the front side (LED side) of the PCB.

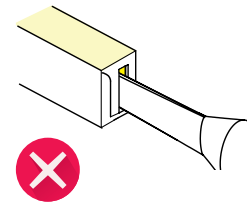
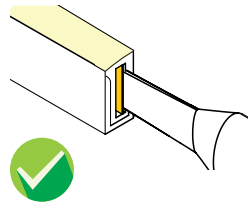
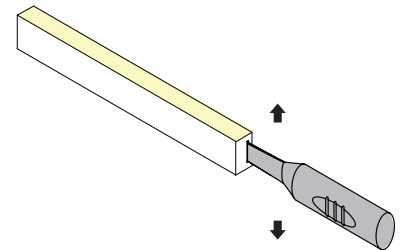
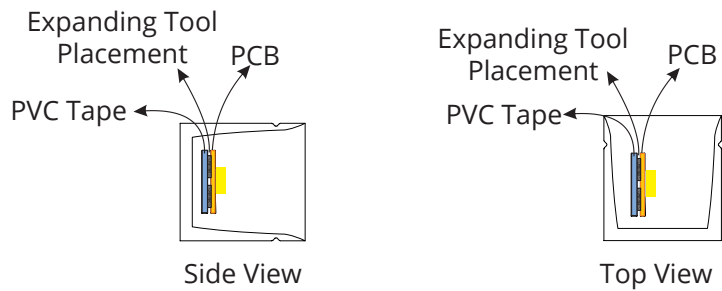

Inserting the expanding tool into the front side of PCB will damage the light

03.2 | Inserting the Lead Connector

Rotate the steel plate so it is aligned straight with the pin connector (Fig. 1).

Carefully insert the pins of the lead connector into the gap you created behind the PCB (Fig. 2).

Swivel Connector

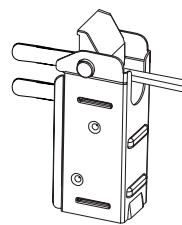

Fig. 1

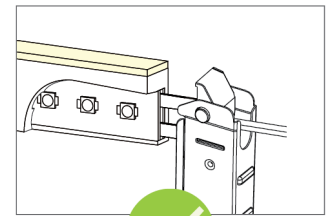

Fig. 2

DO NOT insert the pins into the front side of the PCB. (Fig.3)

DO NOT split the pins around the PCB (Fig.4).

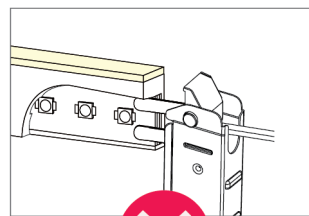

Fig. 3

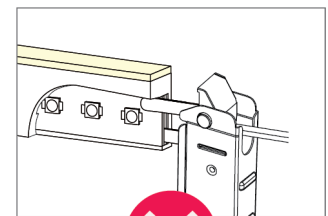
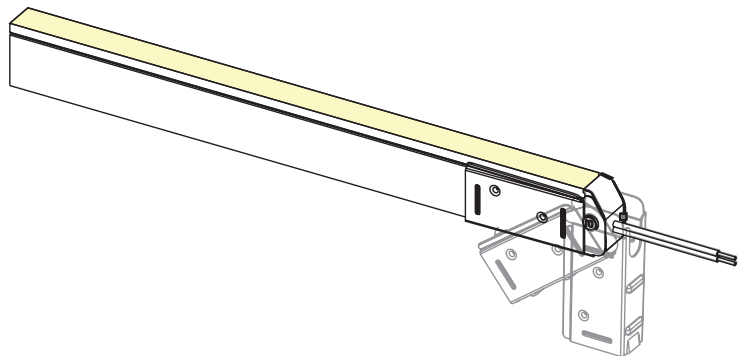

Fig. 4

Swivel Connector & End Cap Assembly

03.3 | Rotate the steel plate up on to the bottom of the fixture. Make sure the bottom of the fixture is flush with the bottom of the steel plate.



03.4 | Installing the Swivel End Cap

Rotate the steel plate 90 degrees so it is aligned with the face of the end cap.

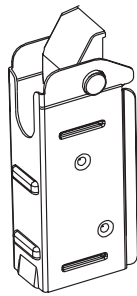

Line up the end fitting with the end of the fixture. Press them together and swing the steel plate into place.

Make sure the bottom of the fixture is flush with the bottom of the steel plate.

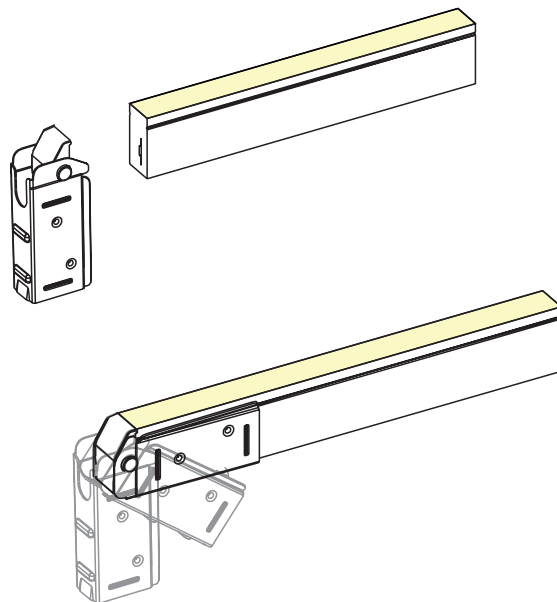

Power your fixture to ensure that it is working properly.

General Wiring Diagrams

Vivid Wave Mini Wiring

- This LED Neon Flex Fixture is only compatible with a 24V power supply.
- Always observe proper polarity.
- Always add an additional 20% to the maximum load when sizing the power supply.
- Ensure that the power cable drawing current is no more than 80% of its current capacity.
- To minimize the voltage drop and maintain light consistency, do not use excessive lengths of wire between the power supply and light fixture.

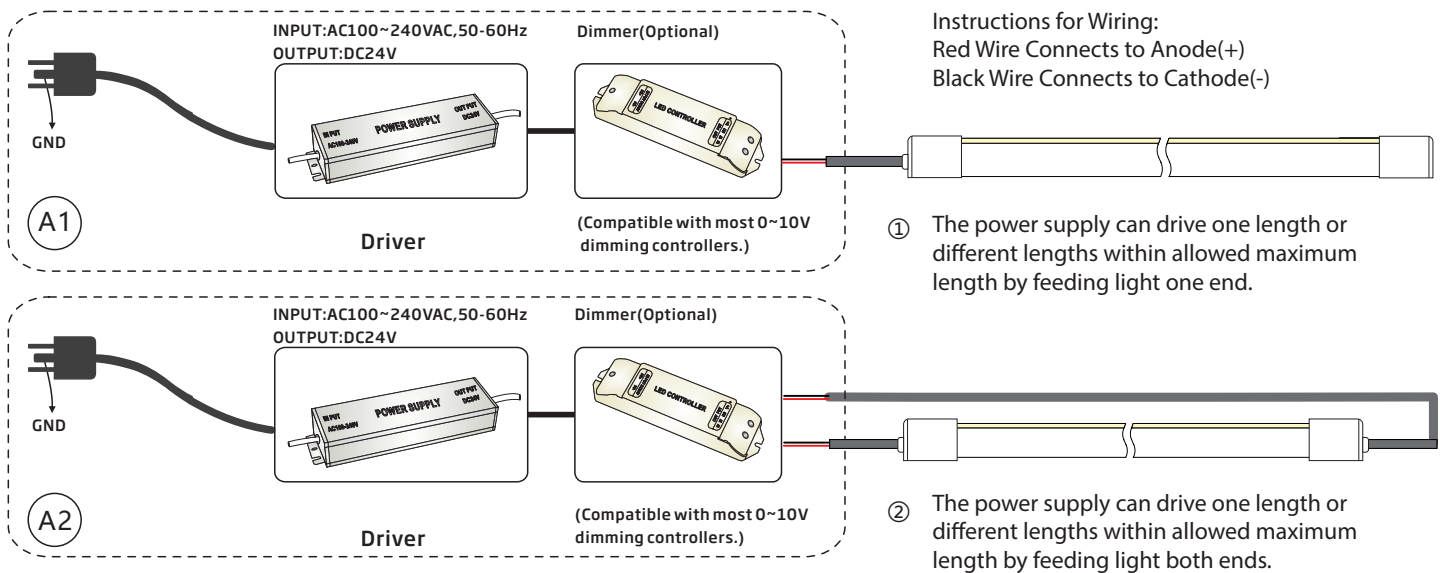

Max Continuous length

Product Number	Color	Single Feed	Double Feed
NF-10F-X-01-2W-E-XXX-24DC	Red/Amber	32.81ft (10m)	65.62ft (20m)
NF-10F-X-01-2W-E-XXX-24DC	Green/Blue/White	49.21ft (15m)	98.43ft (30m)

Mounting Channels

Plastic & Aluminum Channel

Tools for Installation

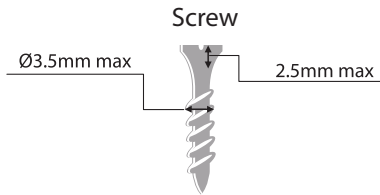

Correct Installation of Plastic & Aluminum Channel

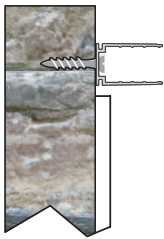
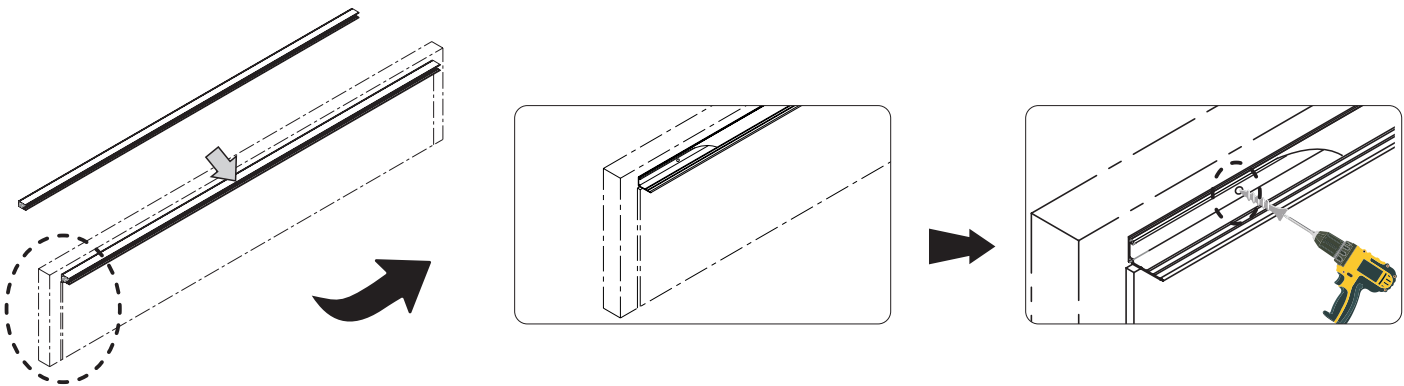

Screw into position and ensure the screw head is flush with the lower base of the aluminum profile.

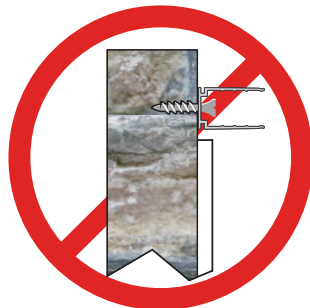

Screw head not flush.



Screw at an angle.

Mounting Channels

Mounting Channel Do's and Don'ts

Snap, Swivel & Submersible Connectors and Ends

Do not put undue stress on the cables or connectors.

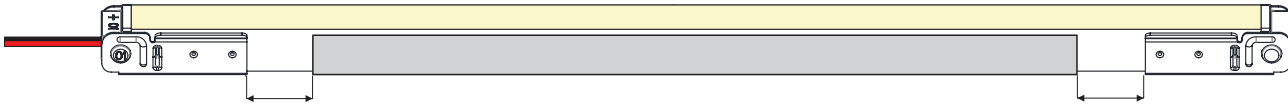

Leave a space of 0.4 to 0.8in (10 to 20mm) between the end of the channel and the connector.

Incorrect Installation Methods

Do not put undue stress on the cables or connectors.

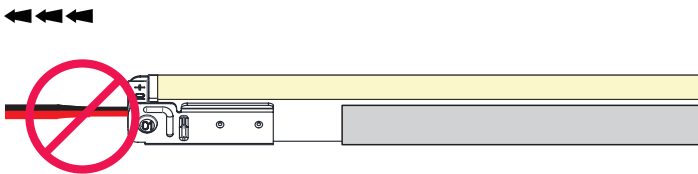

Do not curl or pull the cable with excessive force.

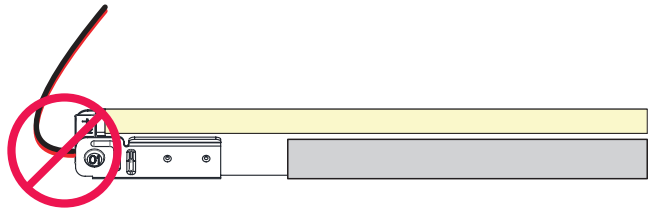

Do not bend the fixture at a sharp angle during installation.

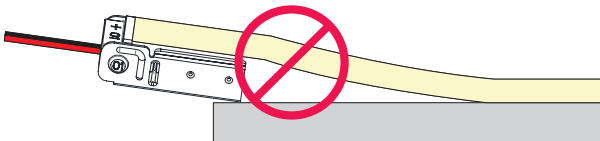

Do not leave a space smaller than 0.4in (10mm) between the connector and the channel.

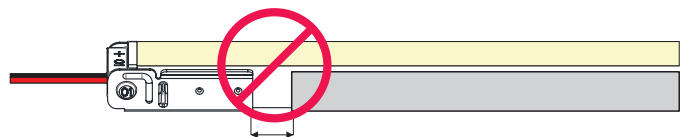

To avoid warping in the center, only install the fixture from one end to the other.

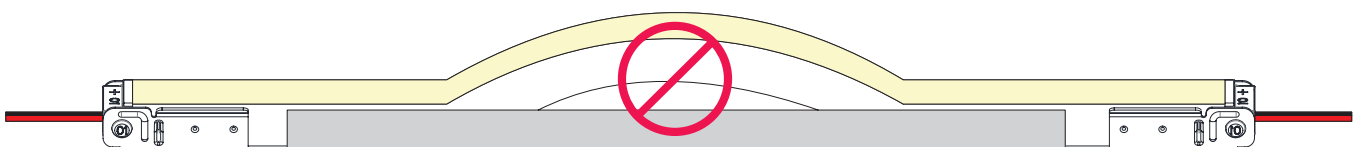

Mounting Channels

Mounting Channel Do's and Don'ts

Seamless Connectors and Ends

Do not put undue stress on the cables or connectors.

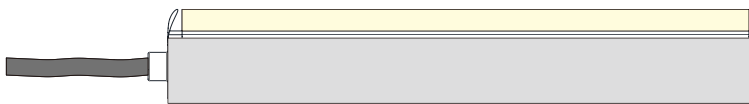
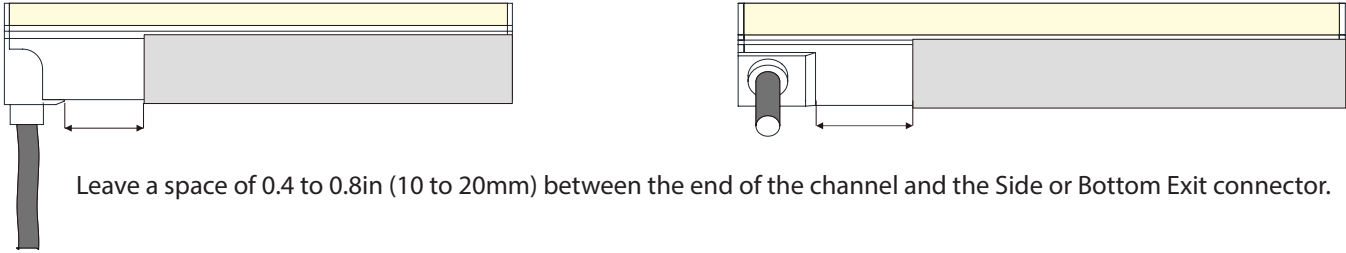

Incorrect Installation Methods

Do not put undue stress on the cables or connectors.

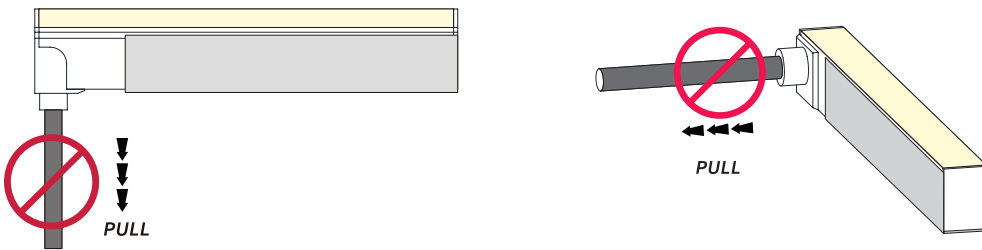

Do not curl or pull the cable with excessive force.

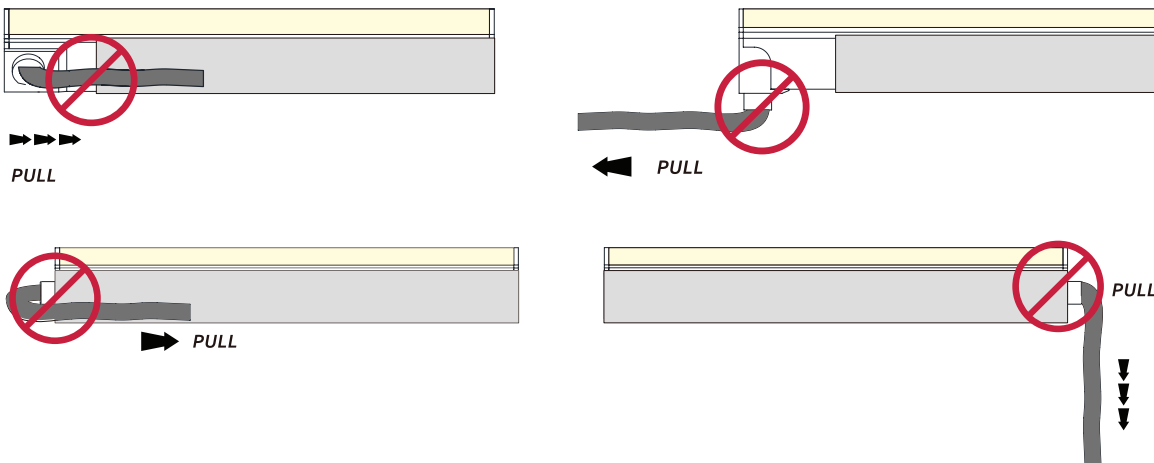

Mounting Channels

Mounting Channel Do's and Don'ts

Seamless Connectors and Ends (cont)

Do not leave a space smaller than 0.4in (10mm) between the connector and the channel.

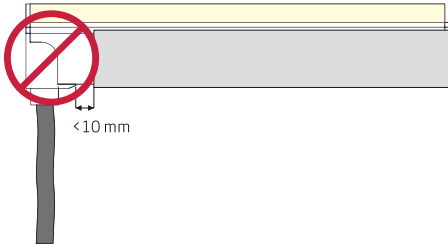

Do not force the connectors to fit into the mounting channel.

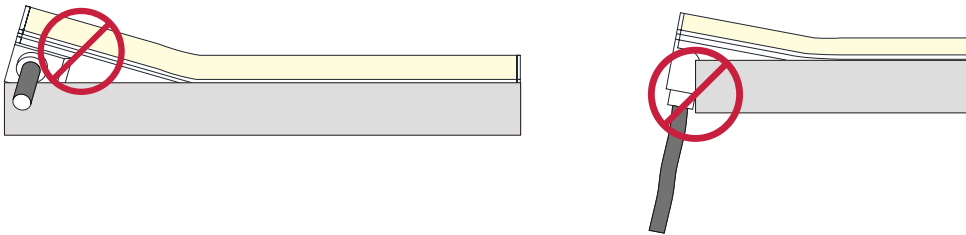

To avoid warping in the center, only install the fixture from one end to the other.

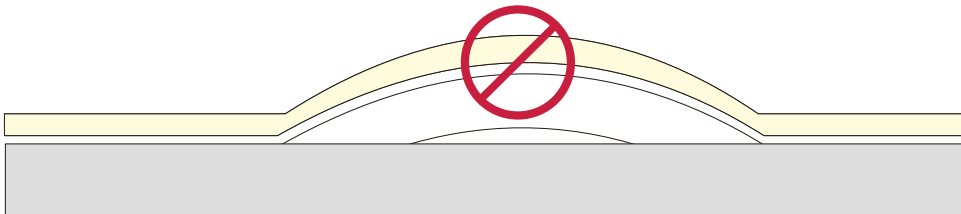

Mounting Channels

Mounting Channel Do's and Don'ts

Correct Bending During Installation

When pressing the fixture into the channel, **do not** bend the fixture at an angle greater than 15 degrees.

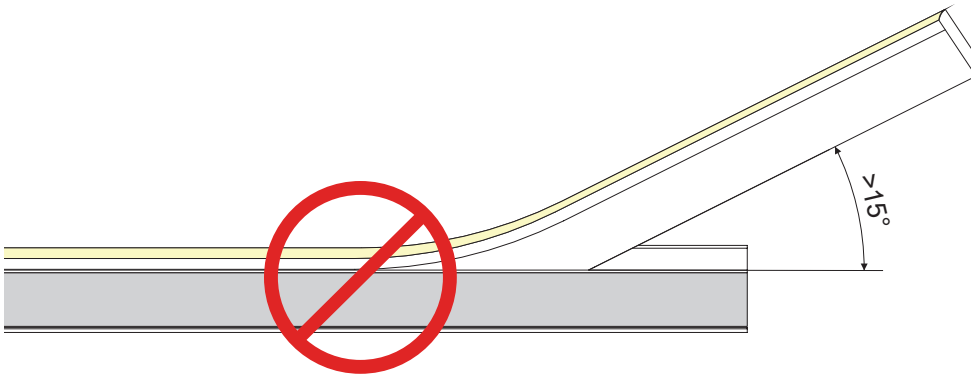
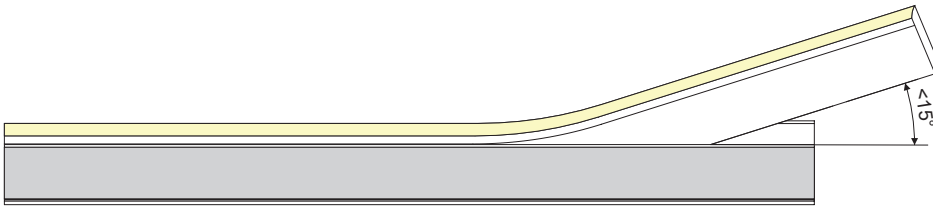

Avoid bending the light at the first cutting unit.

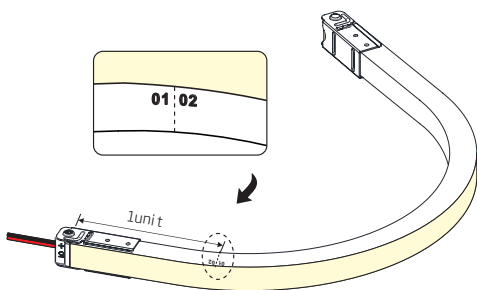

Do not push the fixture to bend smaller than the minimum bending diameter.

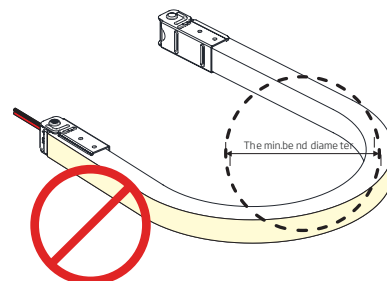
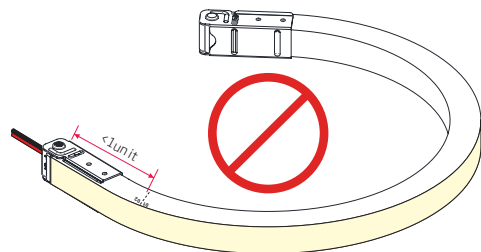
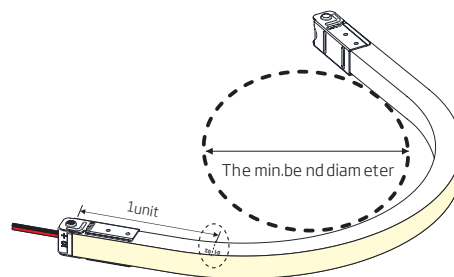

Troubleshooting

Entire fixture doesn't work.

- Check that the power supply is plugged in, switched on and receiving power.
- Check all light, dimmer or controller connections, connecting from the power supply to the fixture.
- Check polarity of all wire connections.
- Make sure power supply output voltage is 24V DC.
- Ensure connector pins are inserted into back side of PCB and properly assembled.
- Make sure your power supply is CV (constant voltage).

Light appears dim or dull at one end.

- Make sure the voltage of the power supply is not lower than that of the light.
- Adjust the dimming level to maximum.
- Attach a lead wire to both ends of the fixture shorten fixture length to prevent voltage drop.

Light appears excessively bright / is hot to the touch.

- Make sure the voltage of the power supply is not higher than that of the light.

If the first segment doesn't work.

- Make sure unit s properly cut. If it has been cut wrong, remove the first segment, cutting it off properly.
- Check for damage done to the first LED from improper installation of the connector. If damage has been done, cut out the first segment and properly assemble the connector.
- Water ingress due to improper connector assembly could cause a short in the first segment. Replace length with a new one.
- External impact damage inside LEDs. Only use your hands to install LED Neon Flex into aluminum profile.

Light is flashing on and off.

- Check the power supply to ensure it supports the length you are using. Select the appropriate strength or install an additional power supply to support your installation.
- Check that the power supply output voltage is stable.
- Check that front connector is properly installed with good contact with the copper PCB.
- Check that the proper controller is connected.

For more information, and troubleshooting, please refer to our Knowledge Base at www.glls.com/knowledge-base/

3 or 5 Year Limited Warranty

Green LED Lighting Solutions (GLLS) provides a standard 3 year (36-month) limited warranty for “LED Neon Flex Vivid” products manufactured with PVC encapsulations from the date of purchase to the original buyer. GLLS also provides a 5 year (60-month) limited warranty for certain “LED Neon Flex Vivid” products when manufactured with Silicone encapsulations from the date of purchase to the original buyer. This limited warranty covers manufacturer defects in the material and workmanship, only on the faulty section of the LED Neon Flex Vivid light. Replacement is provided only on the defective section of the LED Neon Flex Vivid light as defined by its cutting marks. The owner(s) will need to provide proof of purchase at the time of exchange. This Limited Warranty is valid only when LED Neon Flex Vivid lights are used together with LED Neon Flex Vivid approved power supplies, controllers and dimmers for their intended purpose and are properly installed and wired in accordance with all instructions, building codes, the latest UL Standards of Safety, NEC, CSA or any other domestic or international safety agencies.

Standard 3 year limited warranty applies to connectors as well. The 5 year limited warranty on Silicone fixtures will apply to the connectors as well.

Warranty Terms and Conditions

Exclusions

GLLS will not cover damage by abuse, misuse, curvature past the recommended bend radius, punctures, cuts, shortening or splicing outside of the designated cutting marks, disregard for proper cleaning, faulty installation, improper maintenance, including forfeiting the use of a surge protector, or any repairs not carried out by certified LED lighting professionals.

Items not covered by this warranty are those considered as parts which are prone to failure due to normal wear and tear.

GLLS' warranty does not cover any ancillary costs of warranty such as, but not limited to, equipment costs, labor, permits, removal, or reinstallation. GLLS' warranty is a parts only warranty.

Shipping Conditions

All shipping charges should be pre-paid before delivery. If the requested replacement of service is within the terms of the warranty, the item will be returned to the purchaser postage paid. Any shipping damage due to carrier mishandling or improper packaging is the responsibility of the sender. If the product is not within the terms of the warranty GLLS will advise the purchaser of the price of replacement and ship it to the purchaser upon receipt of payment including shipping charges. Please allow 2-4 weeks for return of product. GLLS takes great pride in our products and our customer service and we try to satisfy each situation within the same business day. We cannot be held responsible for shipping delays.

To Obtain Warranty Service

If an LED Neon Flex Vivid S product fails under this warranty, please contact a customer service agent at GLLS www.glls.com or 1-888-850-NEON (6366). GLLS will replace the product at its own discretion, once verification of the defective product is determined. GLLS's liability on any claim shall never exceed the purchase price of the specific product.

Exchanges

All exchanges for products will be honored only after the product has been received by the GLLS warehouse or sales office. The returning product will be inspected by the warehouse or sales staff and will be deemed acceptable or not acceptable. If deemed acceptable, the exchanged product will be shipped to the purchaser. All returns judged not acceptable will receive no refund and will not be returned to the purchaser until the purchaser has paid the return shipping costs.

Shipping on Exchanges

Shipping costs on exchanges will be judged on extenuating circumstances from the original purchase and assessed by the warehouse or sales staff.

Appendix

Correlated Color Temperature (CCT)

ANSI Standard

Nominal CCT Categories

Nominal CCT	Target CCT and tolerance (K)	Target Duv and tolerance
2700K	2725 ± 145	0.000 ± 0.006
3000K	3045 ± 175	0.000 ± 0.006
3500K	3465 ± 245	0.000 ± 0.006
4000K	3985 ± 275	0.001 ± 0.006
4500K	4503 ± 243	0.001 ± 0.006
5000K	5028 ± 283	0.002 ± 0.006
5700K	5665 ± 355	0.002 ± 0.006
6500K	6530 ± 510	0.003 ± 0.006
Flexible CCT (2700-6500K)	$T^2 + \Delta T^3$	$DUVT^4 \pm 0.006$

Remark:

- Six of the nominal CCTs correspond to those in the fluorescent lamp specification 2700K, 3000K (Warm White), 4100K (Cool White), 5000K and 6500K (Daylight), respectively.
- ΔT is given by $\Delta T = 0.0000108 \times T^2 + 0.0262 \times T + 8$.
- Duv is given by $Duv = 57700 \times (1/T) - 44.6 \times (1/T) + 0.0085$.

Recommended Lead Wire Length According to Power Consumption

Note: 1. Follow the parameters in the below chart, lead wires longer than the specified lengths will create voltage drop and eventually affect the lumen output of light.

2. The 0.3m lead wire is not included in this chart.

3. Lead wire length over 10m is NOT recommended unless under special circumstances, especially for addressable lights.

Total Watts	22AWG/0.34mm ²	20AWG/0.53mm ²	18AWG/0.82mm ²	17AWG/1.04mm ²	16AWG/1.38mm ²	14AWG/2.07mm ²	12AWG/3.29mm ²	10AWG/5.62mm ²
10W	118.11ft (36m)	196.85ft (60m)	328.08ft (100m)	393.70ft (120m)	459.32ft (140m)	787.40ft (240m)	1312.34ft (400m)	1968.5ft (600m)
20W	59.06ft (18m)	98.43ft (30m)	164.04ft (50m)	196.85ft (60m)	229.66ft (70m)	393.70ft (120m)	656.17ft (200m)	984.25ft (300m)
30W	39.37ft (12m)	65.62ft (20m)	98.43ft (30m)	124.67ft (38m)	147.64ft (45m)	262.47ft (80m)	426.51ft (130m)	656.17ft (200m)
40W	26.25ft (8m)	49.21ft (15m)	72.18ft (22m)	91.86ft (28m)	114.83ft (35m)	196.85ft (60m)	311.68ft (95m)	459.32ft (140m)
50W	19.69ft (6m)	39.37ft (12m)	59.06ft (18m)	72.18ft (22m)	91.86ft (28m)	157.48ft (48m)	246.06ft (75m)	344.49ft (105m)
60W	16.40ft (5m)	32.81ft (10m)	49.21ft (15m)	59.06ft (18m)	72.18ft (22m)	118.11ft (36m)	196.85ft (60m)	288.71ft (88m)
70W	/	26.25ft (8m)	39.37ft (12m)	45.93ft (14m)	59.06ft (18m)	98.43ft (30m)	164.04ft (50m)	236.22ft (72m)
80W	/	19.69ft (6m)	32.81ft (10m)	36.09ft (11m)	45.93ft (14m)	78.74ft (24m)	131.23ft (40m)	190.29ft (58m)
90W	/	13.12ft (4m)	22.97ft (7m)	26.25ft (8m)	32.81ft (10m)	59.06ft (18m)	98.42ft (30m)	147.64ft (45m)
100W	/	/	16.40ft (5m)	19.69ft (6m)	22.97ft (7m)	39.37ft (12m)	72.18ft (22m)	104.99ft (32m)
110W	/	/	9.84ft (3m)	13.12ft (4m)	16.40ft (5m)	26.25ft (8m)	49.21ft (15m)	72.18ft (22m)
120W	/	/	6.56ft (2m)	8.20ft (2.5m)	9.84ft (3m)	/	26.25ft (8m)	39.37ft (12m)

Loading Chart

Power	35W	60W	75W	80W	100W	120W
7.2W Length	19.69ft (6m)	32.81ft (10m)	39.37ft (12m)	42.65ft (13m)	52.49ft (16m)	62.34ft (19m)
Connections	Single		Double	